

# Nexoedge: nEdge–nCloud

Data Storage Through Edge-Cloud



# Market Overview: Edge Infrastructure

IoT accelerates the development of Edge-Cloud infrastructure which creating a new normal ecosystem that changes the lifestyle of all human beings.

## How Important is Edge? Its Value?

### New Market New Demand

#### Market Size

- According to the Linux Foundation, “Edge computing will be **4x larger than cloud** and will generate 75 percent of data worldwide by 2025.”
- Gartner claims companies generated a modest 10 percent of their data outside a data center or cloud in 2019; this amount is expected to reach 75 percent in the next six years.
- IDC predicts that in three years, 45 percent of IoT-generated data will be stored, processed, analyzed, and acted upon close to or at the edge of networks.

#### Vertical Market Adoption

- 5G, IoT and Edge computing will be necessary to deliver the automation, performance and cognitive insight required by many industries—including manufacturing, healthcare, energy and utilities, among others. Telecom operators will need to embrace open ecosystems to externalize innovation and accelerate new services.”

# Pain Points of Stateful Containers

User/Application

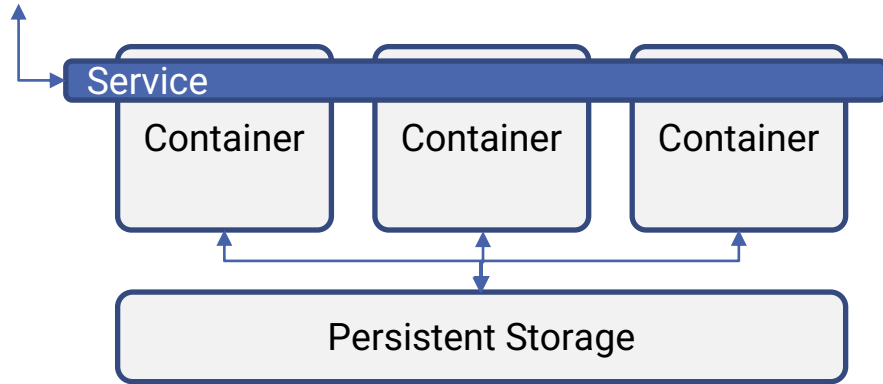

Some facts:

- Over 90% of the applications are deployed in containers\*
- Over 75% of the applications require stateful containers\*

Pain Points:

- Limited local storage resources in clusters (often forcing stateless applications)
- Concerns regarding data security and increased cyberattacks on stored data
- Risk of data loss due to local disk/cluster failure
- Storage at a given cluster is not scalable

\*[CNCF Survey Report 2020](#)

# Pain Points of Containers in CNCF

## What are your challenges in using/deploying containers?

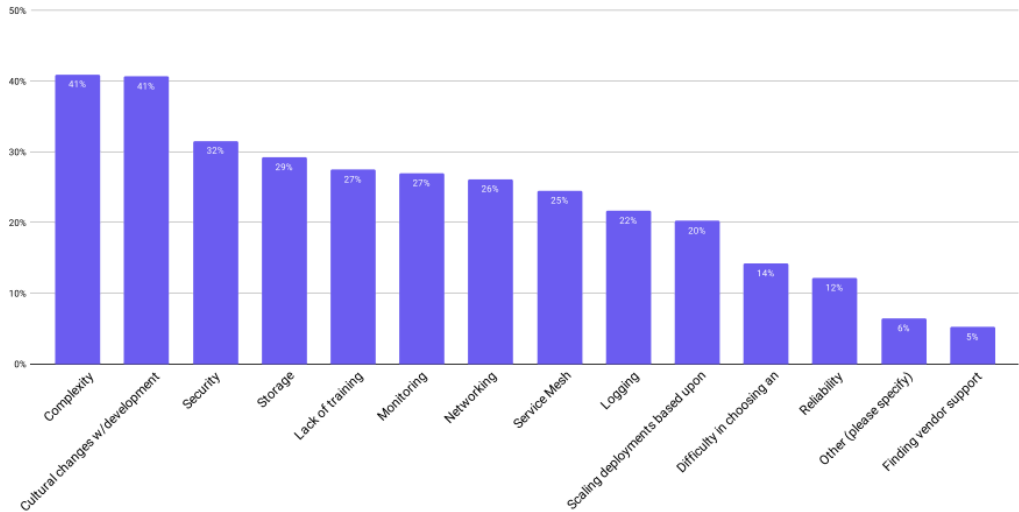

Capture of CNCF Survey Report 2020

In the CNCF SURVEY 2020, we could see pain points on **Security (32%)** and **Storage (29%)** was third and fourth respectively for challenge on cloud native projects.

It is because in cloud native, most resources are ephemeral and unsuitable for keeping data long-term.

Regular storage is tied to the container and has a finite life span.

# Pain Points of Containers in CNCF (cont')

## What are your challenges in using / deploying containers?

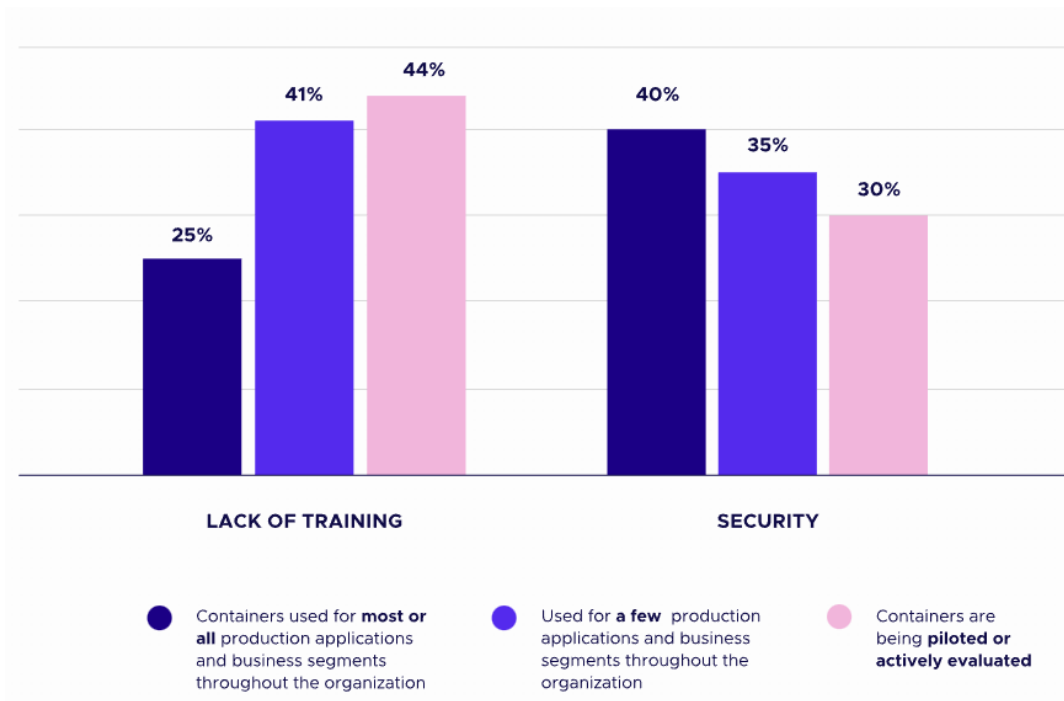

Per capture in the CNCF SURVEY 2022, **Security** was #2 most challenging issue in deploying containers.

Capture of CNCF Survey Report 2022

# nEdge-nCloud Value Propositions

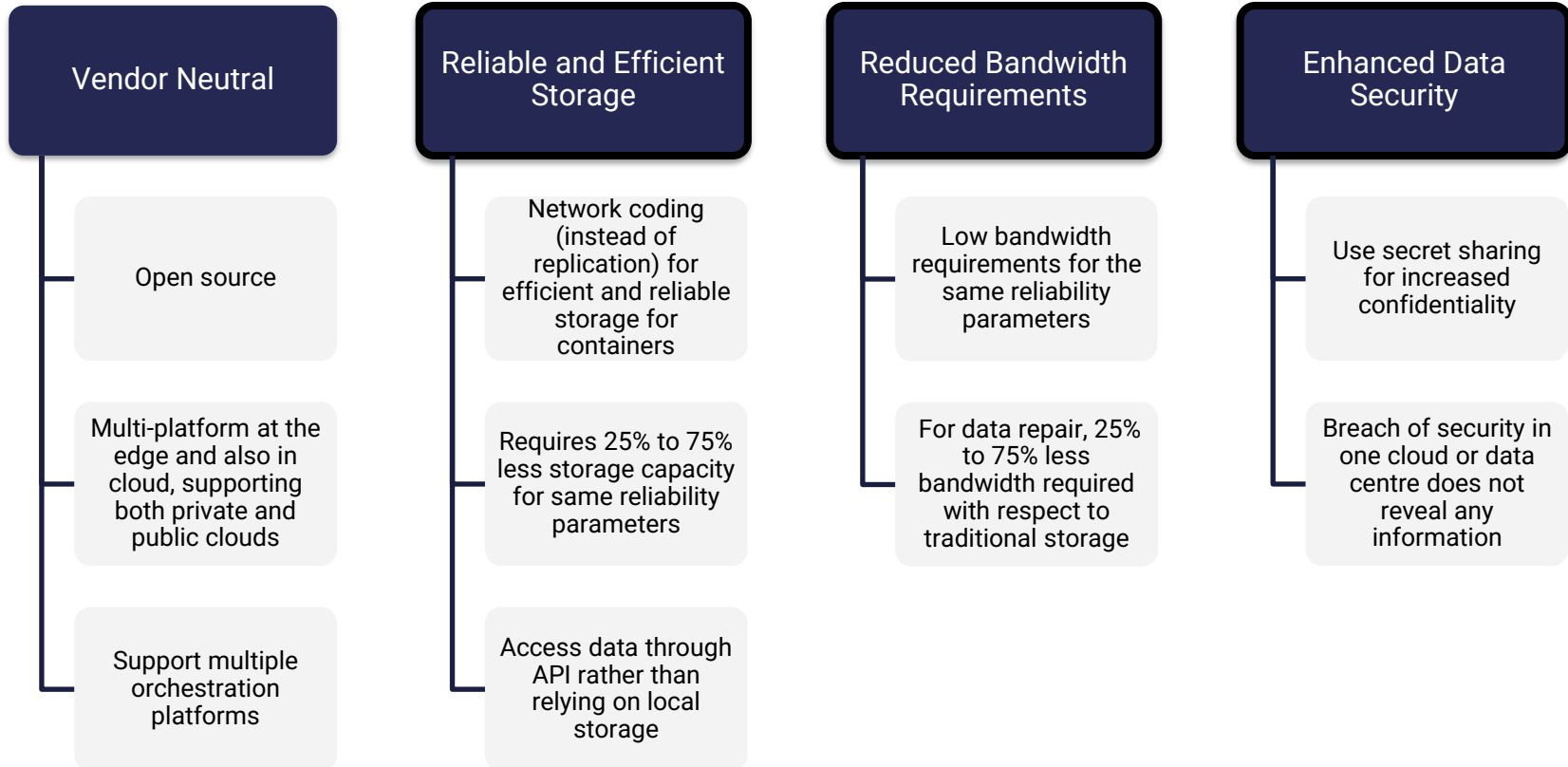

# Persistent Storage for Containers via nEdge-nCloud

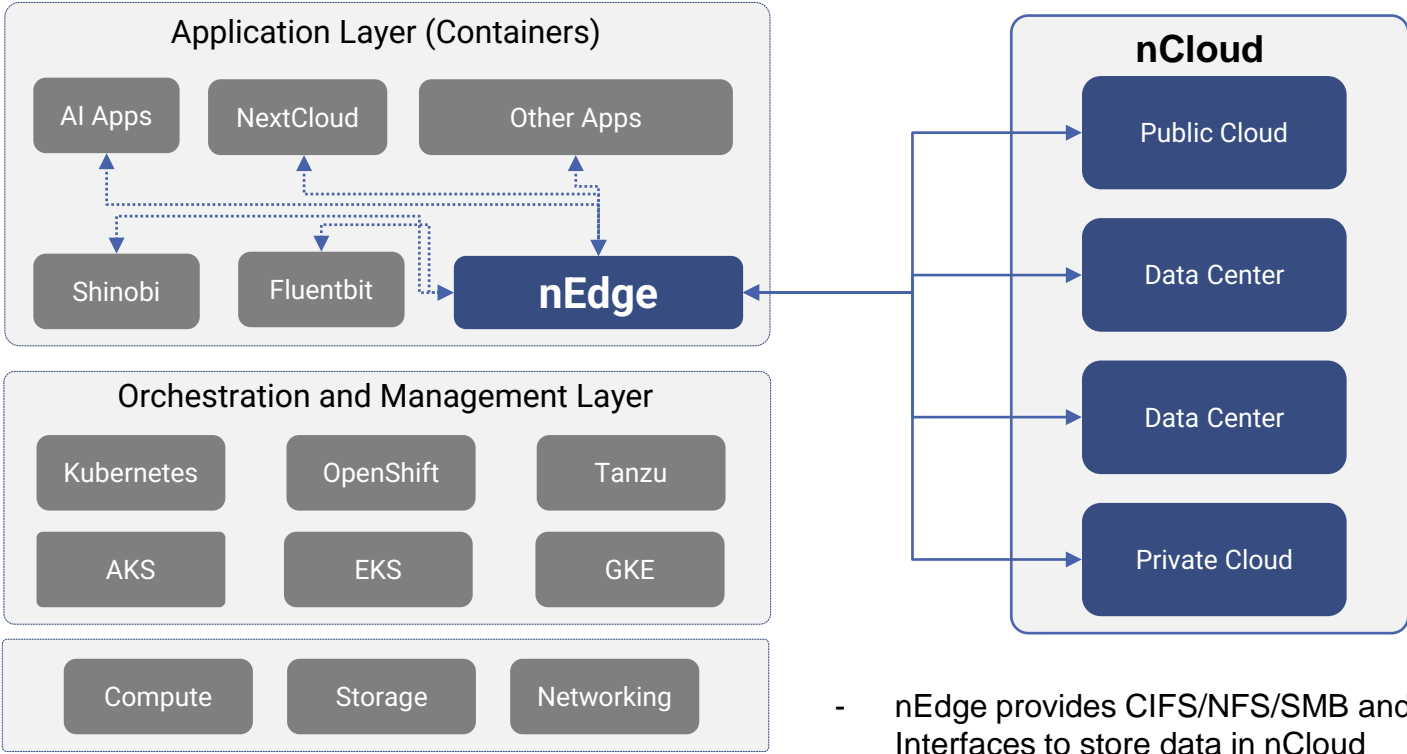

- nEdge provides CIFS/NFS/SMB and S3 Interfaces to store data in nCloud
- nEdge-nCloud supports file storage as well as object storage

# Data Slicing via nEdge-nCloud

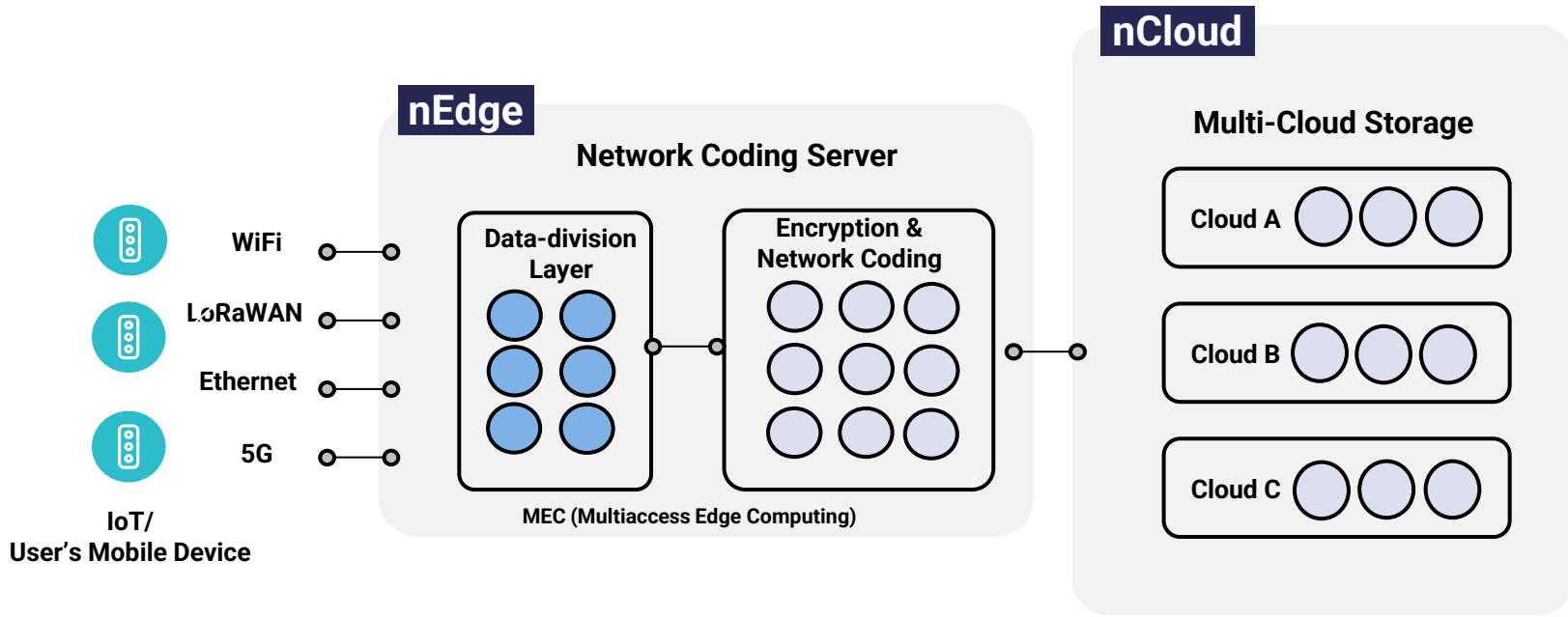

1 Connection and System Access

2 Edge Computation

3 Cloud Storage



# Comparison with Ceph and MinIO

	CU Coding nEdge	Ceph	MinIO
<b>Status</b>	Startup	Part of Red Hat	\$103M Series B in 2022
<b>Data Redundancy over Multiple Clusters</b>	Network Coding	Replication	Replication
<b>Data Redundancy within a Cluster</b>	Network coding for multi-cloud storage	Erasure coding	Erasure coding
<b>Disaster Recovery Method</b>	Built-in via multi-cloud storage	Synchronous replication to remote clusters	Synchronous replication to remote clusters
<b>Storage Method</b>	Object, file storage	Block, object, file	Object
<b>Vendor Neutral</b>	Yes	Yes	Yes

# Comparison with Ceph and MinIO

Ceph and MinIO

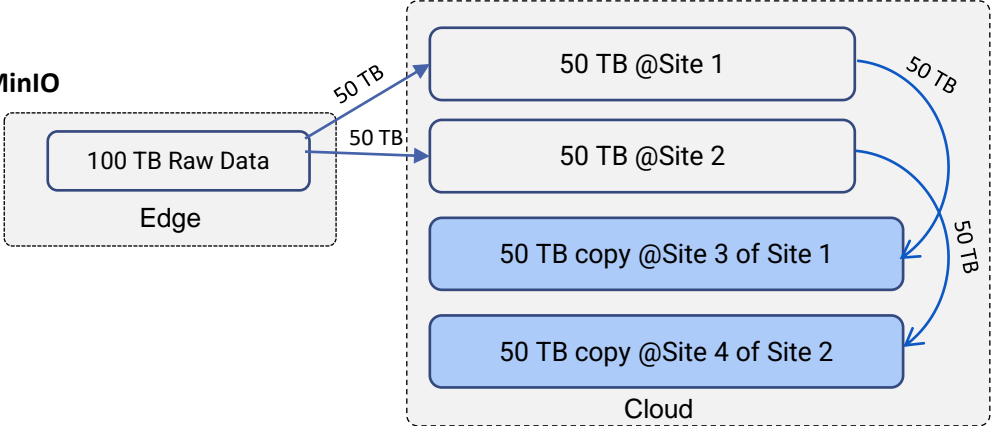

nEdge-nCloud

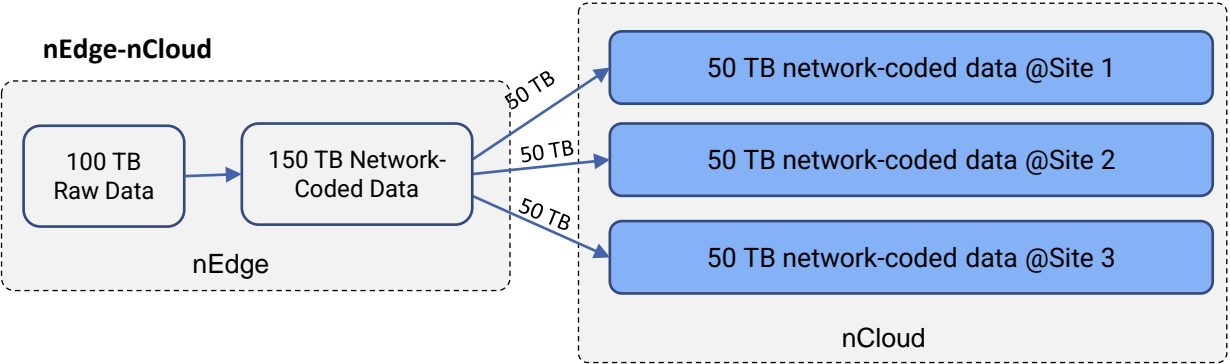

Ceph and MinIO require 4 transfers of 50 TB whereas nCloud requires 3 transfers of 50 TB for the same storage reliability

- Failure of one site can be tolerated by all three solutions
- To read all the data, access to only two sites is required for all three solutions
- Ceph and MinIO do replication of site 1 and 2 to tolerate loss of any one site out of 4 sites
- nEdge-nCloud does network coding and only requires 3 sites to tolerate loss of one site.

# nEdge-nCloud – Performance Benefits

Enhanced Storage  
Reliability

Low Repair Bandwidth

Enhanced Data Security

# nEdge-nCloud – Enhanced Storage Reliability

- Data redundancy: Encode and distribute data to data centers
  - Lower storage overhead than replication (i.e., storing multiple data copies)
  - Data recovery: File is recoverable from any six pieces of data in the data centers

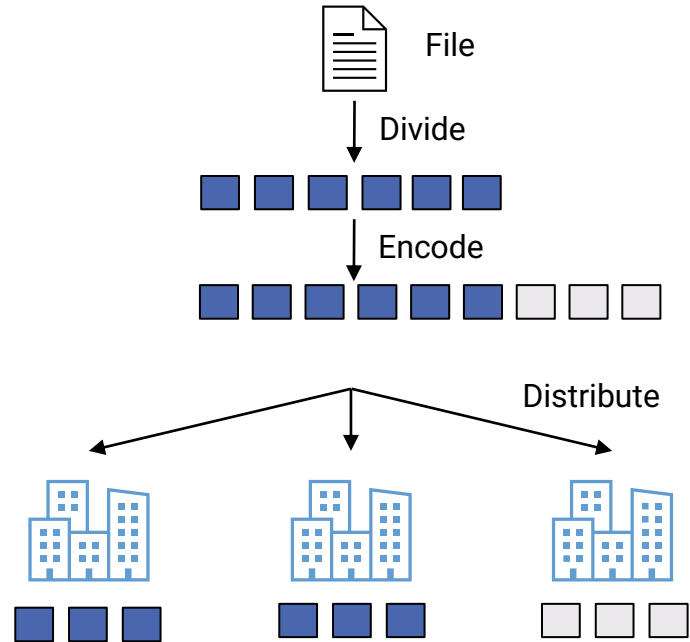

# nEdge-nCloud – Low Repair Bandwidth

- Single piece lost
- Conventional repair
  - Transfer four pieces from remote data centers
  - Decode for the lost piece
- Problem
  - Limited network bandwidth across data centers
  - Significant data transfer across data centers: Long repair time.

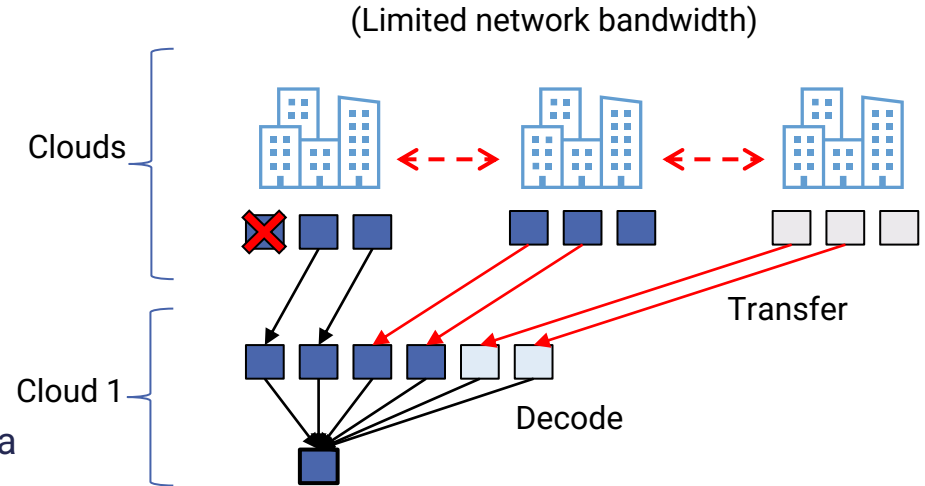

# nEdge-nCloud – Low Repair Bandwidth

- Single piece lost
- Network-coding-based repair
  - Encode pieces in each data center
  - Transfer two encoded pieces from remote data centers
  - Decode for the lost piece
- Save half of the data transfer across data centers compared with conventional repair

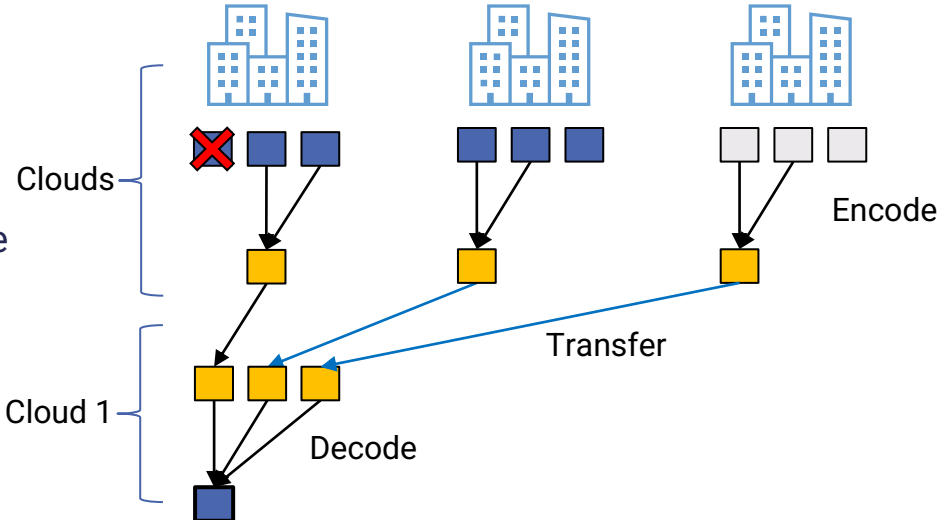

# nEdge-nCloud – Enhanced Data Security

- Transformation of data by secret sharing
- Data in individual pieces appears to be random.
- Require sufficient pieces of data to reveal the original data.
  - Avoid partial data disclosure when a data center is compromised.

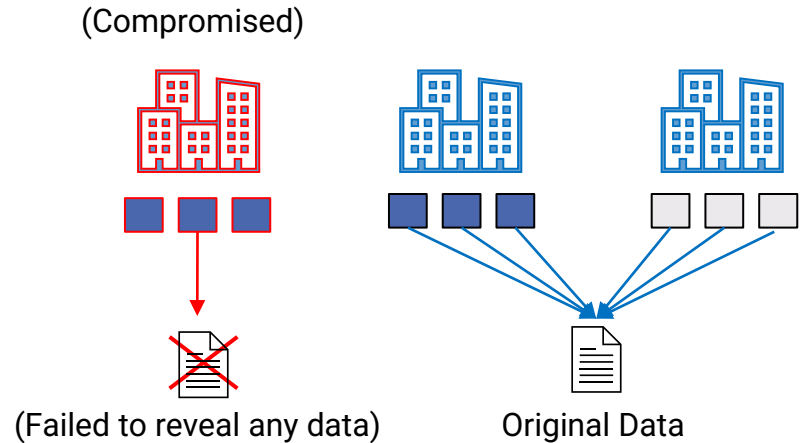

At least 6 pieces are required to view original data  
Only 3 pieces are compromised. Hence, no information leak.

# nEdge-nCloud – Enhanced Data Security

## Secret Sharing

- Input: secret; output: multiple shares
- Secret is recoverable from enough shares
  - ➔ Reliability
- Secret is inaccessible without enough shares
  - ➔ Security

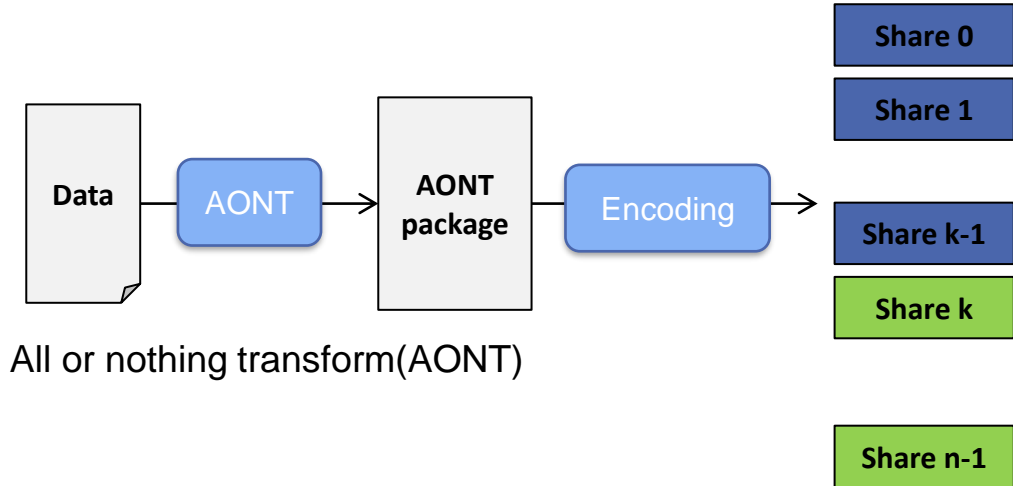



# Our Founders – Professors & Alumni from CUHK



**Prof. PC CHING**  
*CUHK EE Prof.*



**Prof. Song LIEW**  
*CUHK IE Prof.*



**Prof. Raymond YEUNG**  
*CUHK IE Prof.*



**Prof. Patrick LEE**  
*CUHK CSE Prof.*



**Joseph WONG**  
*CUHK Alumni*



**Aldous NG**  
*CUHK Alumni*

**Thank you!**